

ERSATZTEILLISTE / SPARE PARTS LIST



JETVAC SD







The New JETVAC - Generation SD

- 1. ACCESSORIES 3
 - 1.1 JETVAC SD 7 3
 - 1.2 JETVAC SD 12 and JETVAC SD 12 D - **Model discontinued** - 4

- 2. SPARE PARTS 5
 - 2.1 JETVAC SD 7 5
 - 2.2 JETVAC SD 12 and JETVAC SD 12 D – **Model discontinued** - 8

1. ACCESSORIES

1.1 ACCESSORIES JETVAC SD 7

Picture	Art.No.	Article description	Unit
	176 07 07	Dust bags, fleece for SD 7 <ul style="list-style-type: none"> • 10 pieces • Dust category M • Dimensions - B x L: 310 mm x 330 mm • Approx. 7 l Volume 	1
	176 99 32	Hard cover nozzle in black suitable for all SD-Models <ul style="list-style-type: none"> • Working width: 360 mm • Hard floor nozzle for easy and effective cleaning of hard floor coverings such as tiles, PVC or linoleum • Soft bristles protect floors and ensure effective dirt pick-up 	1
	176 99 33	Accessory set of nozzles, black, 3 pieces (Standard for JETAVC SD 12 und SD 12 D) <ul style="list-style-type: none"> • Includes crevice nozzle, suction brush and upholstery nozzle • Attachment diameter: 35 mm 	1
	176 99 16	Motor protection filter, fleece suitable for all SD-Models <ul style="list-style-type: none"> • 3 pieces • To be changed if heavily soiled. 	1
	176 99 23	Manifold with false air slide in black <ul style="list-style-type: none"> • Rubber grip • False air slider in light grey • Antistatic 	1
	176 99 31	Combination floor nozzle suitable for all SD-Models <ul style="list-style-type: none"> • Working width: 280 mm • Diameter: 35 mm 	1

1.2 ACCESSORIES JETVAC SD 12 and JETVAC SD 12 D – MODEL DISCONTINUED -

Picture	Art.No.	Article description	Unit
	176 12 12	Dust bags, fleece for SD 12 <ul style="list-style-type: none"> • 10 pieces • Dust category M • Dimensions - B x L: 365 mm x 440 mm • Approx. 12 l Volume 	1
	176 12 13	HEPA-13 Filter for SD 12 <ul style="list-style-type: none"> • B x L x H: 73 x 165 x 45 mm • Colour: Black <p>Standard for JETVAC SD 12 D (Art. No. 176 12 01)</p>	1
	176 12 35	Turbo floor nozzle in black suitable for SD 12-Models <ul style="list-style-type: none"> • Working width 280 mm • Height: 75 mm • Gentle, intensive brushing reveals and removes even stubborn dirt and pet hair 	1
	176 99 32	Hard cover nozzle in black suitable for all SD-Models <ul style="list-style-type: none"> • Working width: 360 mm • Hard floor nozzle for easy and effective cleaning of hard floor coverings such as tiles, PVC or linoleum • Soft bristles protect floors and ensure effective dirt pick-up 	1
	176 99 16	Motor protection filter, fleece suitable for all SD-Models <ul style="list-style-type: none"> • 3 pieces • To be changed if heavily soiled. 	1

SPARE PARTS

1.3 SPARE PARTS JETVAC SD 7

Picture	Art.No.	Article description	Unit
	176 07 14	Filter basket SD 7 <ul style="list-style-type: none"> • Usable as main filter • Plastic frame, reinforced fleece • Washable up to 40°C • Approx. 7 l Volume 	1
	176 07 21	Plastic suction tube in black for SD 7 <ul style="list-style-type: none"> • 2 parts • Single measures – B x L: 35 mm x 505 mm 	1
	176 07 76	Replacement power cable for SD 7 in VERMOP Signal yellow <ul style="list-style-type: none"> • ATTENTION: Replacement is only allowed by qualified electricians! • 7,5 m length 	1
	176 99 25	Suction hose in black suitable for all SD-Models <ul style="list-style-type: none"> • 2 m length • Diameter 35 mm • Click closure system 	1
	176 07 31	Combination floor nozzle SD 7 <ul style="list-style-type: none"> • Working width: 270 mm • Diameter: 35 mm 	1
	176 99 75	Repair kit for suction hose connections <ul style="list-style-type: none"> • 3-/4 parts • Consisting of connecting sleeve, seal and thread incl. clamping ring 	1



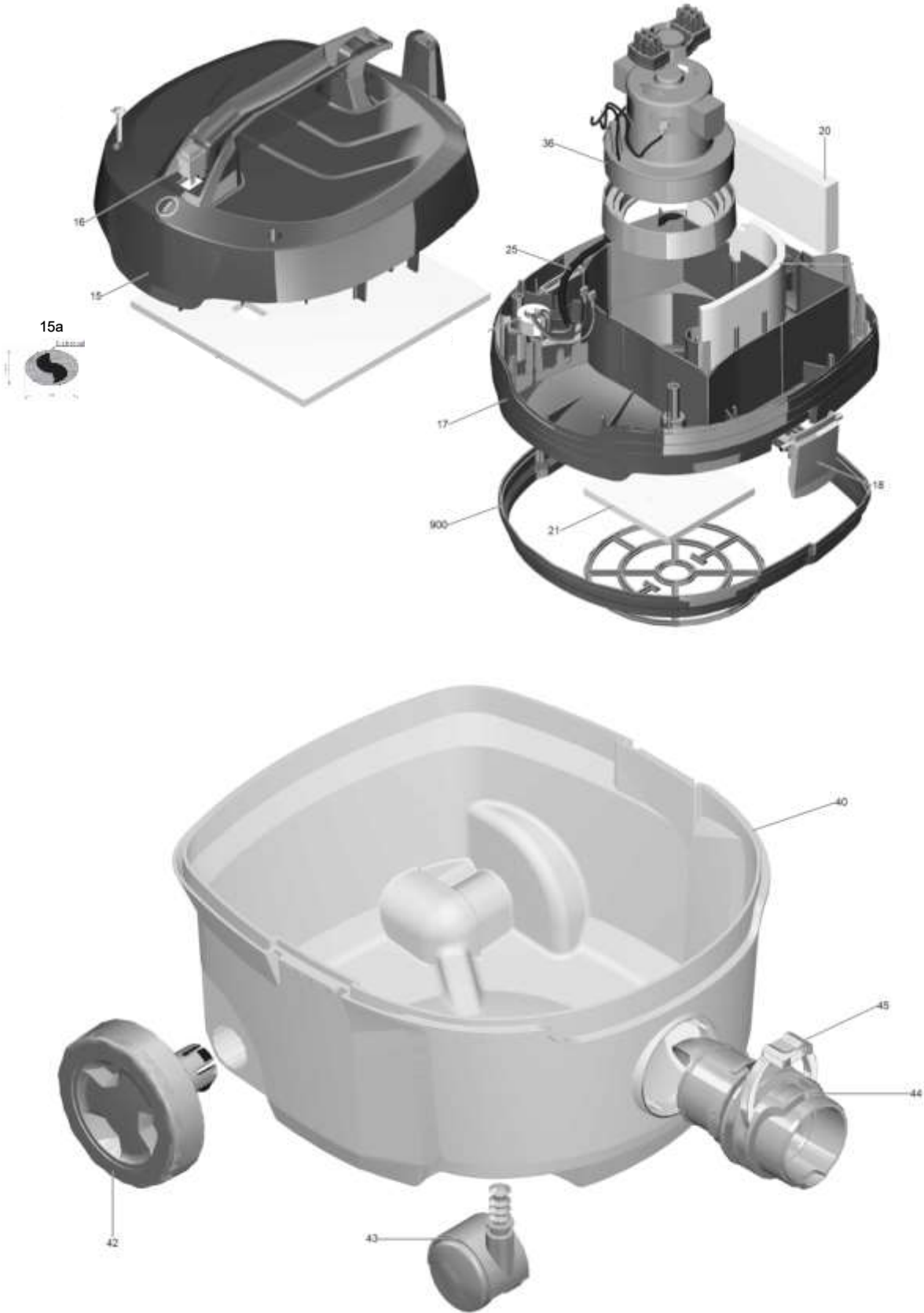





JETVAC SD 7



JETVAC SD 7

No.	Art.No.	Article description	Unit
15	176 07 40	<ul style="list-style-type: none"> Hood SD 7 VERMOP anthracite (RAL B 7043) 	1
15a	176 07 65	<ul style="list-style-type: none"> VERMOP Logo, straight 	1
16	176 07 66	<ul style="list-style-type: none"> POWER button SD 7, VERMOP yellow (RAL 1003) ATTENTION: Replacement is only allowed by qualified electricians! 	1
17	176 07 41	<ul style="list-style-type: none"> Base plate SD 7 VERMOP anthracite (RAL B 7043) 	1
18	176 07 45	<ul style="list-style-type: none"> SD 7 locking tabs in VERMOP grey (RAL A 7042) 	2
20	176 07 51	<ul style="list-style-type: none"> Exhaust air filter SD 7 	1
21	176 99 16	<ul style="list-style-type: none"> Motor protection filter (see overview above) 	3
25	176 07 76	<ul style="list-style-type: none"> Power cable PVC, 7,5m in VERMOP yellow (RAL 1003), see overview above 	1
36	176 07 50	<ul style="list-style-type: none"> Turbine SD 7 complete 	1
40	176 07 44	<ul style="list-style-type: none"> Container SD 7 in VERMOP grey (RAL A 7042) 	1
42	176 07 61	<ul style="list-style-type: none"> Wheel SD 7 	2
43	176 07 60	<ul style="list-style-type: none"> Swivel castors SD 7 	2
44	176 99 26	<ul style="list-style-type: none"> Suction connection 	1
45	176 99 27	<ul style="list-style-type: none"> Safety clip ring in VERMOP grey (RAL A 7042) 	1
900	176 07 14	<ul style="list-style-type: none"> Filter basket SD 7 (see overview above) 	1

1.4 SPARE PARTS JETVAC SD 12 and JETVAC SD 12 D – MODEL DISCONTINUED -

Picture	Art.No.	Article description	Unit
	176 12 14	Filter basket SD 12 <ul style="list-style-type: none"> • Usable as main filter • Nylone plastic frame • Washable up to 40°C • Approx. 12 l Volume 	1
	176 12 21	Telescopic suction tube <ul style="list-style-type: none"> • 1 m length • Diameter 35 mm • Height adjustable 	1
	176 12 51	Exhaust filter for SD 12 <ul style="list-style-type: none"> • 3 pieces • To reduce the filtered working air • Foam material 	1
	176 12 76	Replacement power cable for SD 12-Models in VERMOP Signal yellow <ul style="list-style-type: none"> • Pluggable cable (Screwed) • Self assembly possible • 12 m length 	1
	176 99 23	Manifold with false air slide in black <ul style="list-style-type: none"> • Rubber grip • False air slider in light grey • Antistatic 	1
	176 99 25	Suction hose in black suitable for all SD-Models <ul style="list-style-type: none"> • 2 m length • Diameter 35 mm • Click closure system 	1
	176 99 31	Combination floor nozzle suitable for all SD-Models <ul style="list-style-type: none"> • Working width: 280 mm • Diameter: 35 mm 	1
	176 99 75	Repair kit for suction hose connections <ul style="list-style-type: none"> • 3-/4 parts • Consisting of connecting sleeve, seal and thread incl. clamping ring 	1
	176 99 33	Accessory set of nozzles, black, 3 pieces (Standard for JETAVC SD 12 und SD 12 D) <ul style="list-style-type: none"> • Includes crevice nozzle, suction brush and upholstery nozzle • Attachment diameter: 35 mm 	1

JETVAC SD 12 and SD 12 D

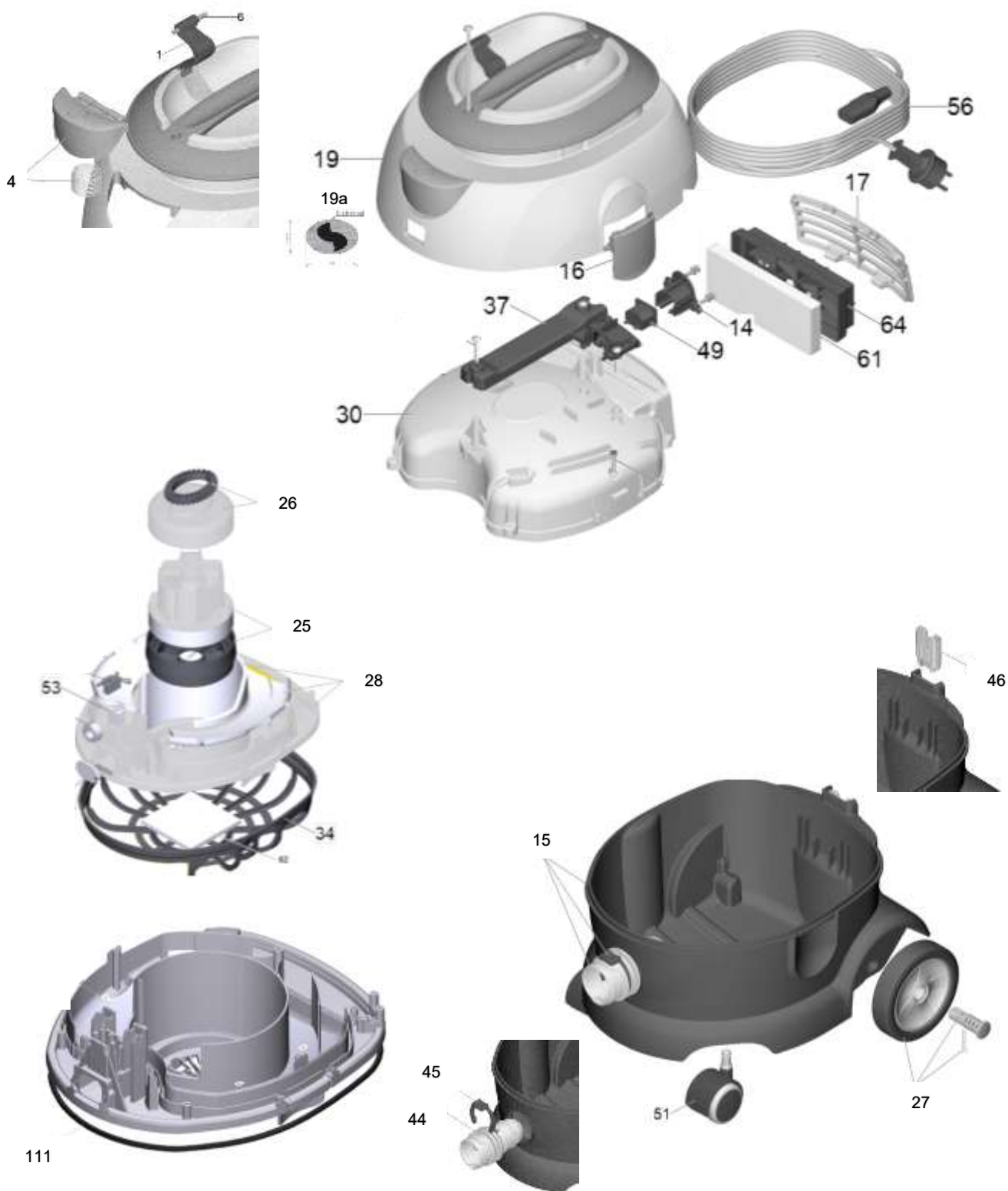

JETVAC SD 12 and SD 12 D

No.	Art.No.	Article description	Unit
1	176 12 78	• Cable hook SD 12, black	1
4	176 12 66	• POWER button SD 12 complete, VERMOP yellow	1
6	176 12 86	• Cable hook pin, 5m6x50 ISO 2338	1
14	176 12 77	• Strain relief SD 12, screwed	1
15	176 12 44	• Container SD 12 complete incl. No. 44 + 45	1
16	176 12 45	• SD 12 locking tabs in grey, RAL A 7042	2
17	176 12 53	• Fan outlet grille in grey (RAL A 7042)	1
19	176 12 40	• Hood SD 12 VERMOP anthracite (RAL B 7043)	1
19 a	176 12 65	• VERMOP Logo, convex	1
25, 26, 28	176 12 50	• Suction turbine SD 12 complete, incl. housing	1
27	176 12 61	• Wheel SD 12 complete in black	2
30, 37	176 12 47	• Air duct housing incl. adapter SD 12	1
34	176 12 14	• Filter basket SD12 (see overview above)	1
44	176 99 26	• Suction connection	1
45	176 99 27	• Safety clip ring in VERMOP grey (RAL A 7042)	1
46	176 12 22	• Intake manifold bracket, molded part in black	1
49	176 12 75	• E-small parts plug-in cable SD12	1
51	176 12 60	• Swivel castors SD 12	2
53	176 12 67	• Power on/off switch • ATTENTION: Replacement is only allowed by qualified electricians!	1
56	176 12 76	• Power cable, 12m in VERMOP yellow (RAL 1003) (see overview above)	1
61	176 12 51	• Exhaust air filter (see overview above)	3
62	176 99 16	• Motor protection filter (see overview above)	3
64	176 12 48	• Filter housing	1
111	176 12 90	• Foam rubber sealing cord D6	1